

TECHNICAL DATA

- Size: 24.6 x 45.9mm (~ 25x46 mm)
- 4 x 4 mm mounting holes
- 2 Layers, Green finish
- 1. Q5.1 GND
- 2. Q5.2 VCC
- 3. Q5.4 DATA
- 4. Q5.3 CLK
- 5. Q5.6 SW + LNK1 & 2
- 6. Q5.5 SW
-
- Link 1: NC When closed SW is connected to GND
- Link 2: NO When closed SW is connected to VCC



ORDERING INFORMATION

Blank PCB for Q5-100 With 6x1 PCB Header
6x1 header supplied loose

Q5-PCB-V1



Q5-100

FEATURES

Programmable LCD-Key

FSTN Display with 64 * 32 dots

RGB Backlight with 1 – 250 mcd/m²

SPI Bi-directional Data Transfer

Viewing Area 17.26 * 12.78 mm²

65k Backlight colours

Display update < 1ms

Lifetime > 3 million operations

Area 20.6 * 18.2 mm²

Backlight colours extremely stable

Display read back function

MTBF > 800.000h

Consumption

Circuit Consumption with

No backlight

5mA

White Backlight

max 65 mA

VIL input low level voltage @ 5V

min -0,3 V

max 0,3 * Vdd

VIH input high level voltage @ 5V

min 0,7 * Vdd

max Vdd + 0,3 V

There are 2 RGB LEDs with maximum 20 mA for each color for both LEDs together.

LED's get PWM Current with ca. 380 Hz cyclus time. Current jumps between 4 levels:

All LED's «off» 5 mA, for each colour «on» There are additional 20 mA per colour in active PWM phase.

SWITCH

Circuit: SPST

Resistive load 5 V @ 20 mA

Insulation resistance 100 Mega ohms Ω minimum @100 V DC Contact resistance 100 Ohm maximum @ 5 V 20 mA Dielectric strength 125V AV for 1 minute minimum Mechanical endurance > 3.000.000 operations

Electrical endurance > 3.000.000 operations

Operating force 2.3 +/- 0.4 Newton

Total travel 2.0 mm

Tactile load/travel see diagram:

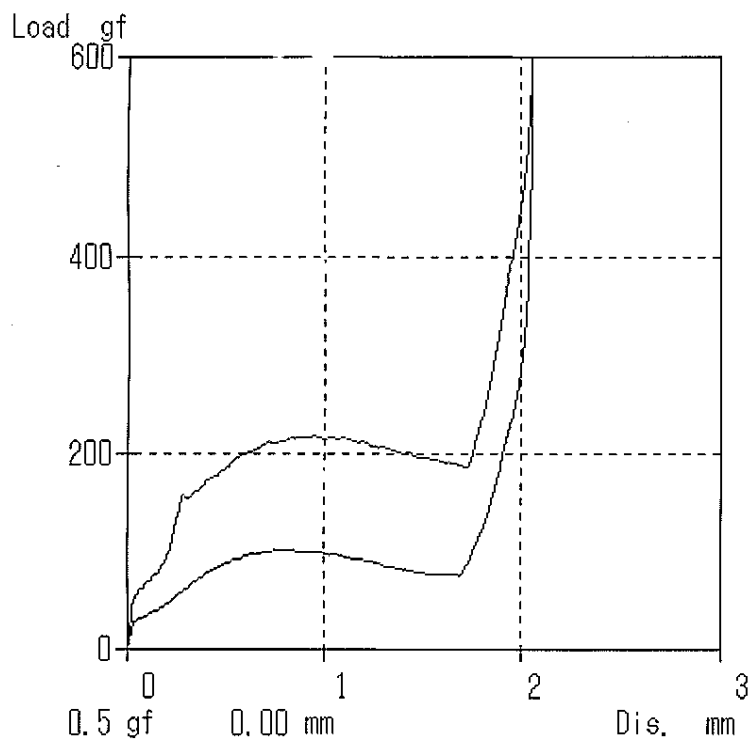

DISPLAY

Display operation mode FSTN positive, MUX 1:32, BIAS 1/6
 Transflective Display with RGB-LED backlight
 Viewing angle direction 6 o'clock
 Viewing area 17.26 mm * 12.78 mm
 Pixel format 64 x 32 pixels
 Pixel size 0.25 * 0.38 mm²
 Pixel pitch 0.27 * 0.40 mm²
 Operating temperature range -10° to +70° Celsius
 Storage temperature range -20° to +80° Celsius
 V_{lcd} 4.9 V to 5.1 V
 All Dots selectable, addressing see diagram

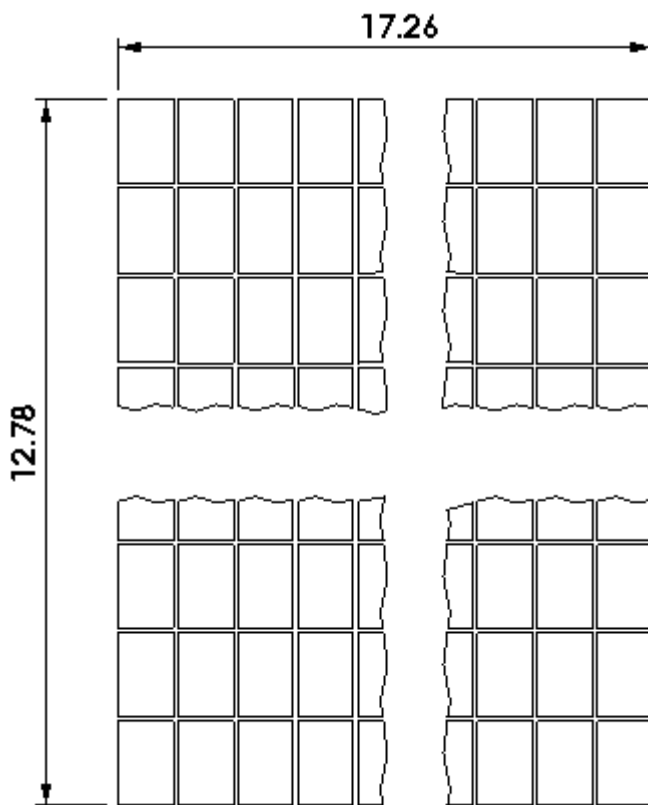

Dimensions active area

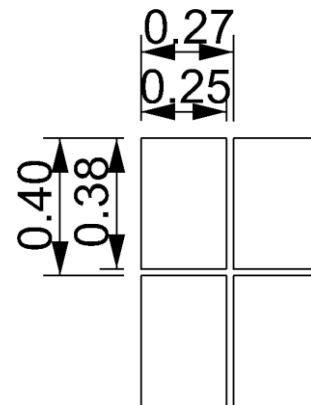

Dimensions dot size and dot pitch

BACKLIGHT

Dominant wavelength: Red 635 nm, Green 525 nm and Blue 470 nm typ.

Peak wavelength: Red 650 nm, Green 515 nm and Blue 468 nm typ.

Red backlight brightness 0.7 to 80 cd/m²

Green backlight brightness 0.12 to 150 cd/m²

Blue backlight brightness 0.2 to 20 cd/m²

White backlight brightness 2.0 to 250 cd/m²

White backlight colour $x = 0.333 \pm 0.020$, $y = 0.333 \pm 0.020$

Backlight brightness adapted to eye sensitivity and colour response

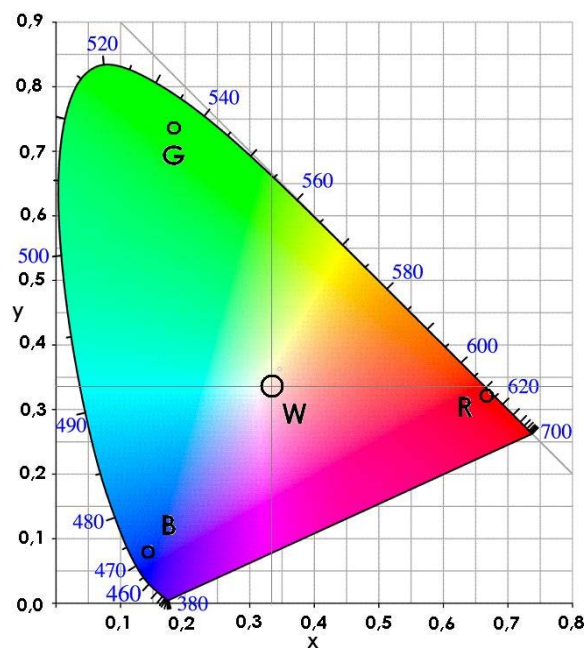

CIE 1931 colour space with some Q5 colours

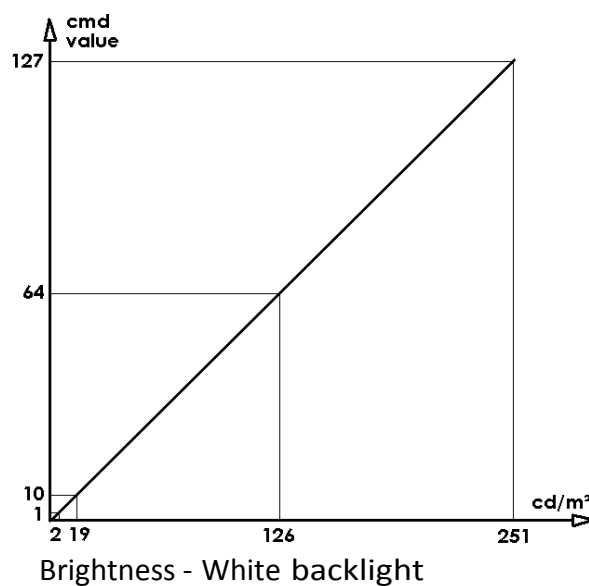

SPI communication

→ The Serial Peripheral Interface (SPI) of Q5 allows simplex, synchronous, serial communication with external devices. An SPI system may consist of a master and one or more LCD-Key Q5 slaves.

→ To use a single data line (pin SDA of Q5), the MISO and MOSI pins are connected together inside the Q5 (only simplex communication is possible). Chip Select pin is not available with Q5. To ensure synchronisation with the master, an internal buffer overflow and time out are integrated in Q5.

→ The communication is always initiated by the master. When the master device transmits data to a slave Q5 via MOSI pin, the slave device is able to respond by sending data to the master device via the MISO pin. This implies simplex communication with both data out and data in synchronized with the same clock signal which is provided by the master device via the SCK pin.

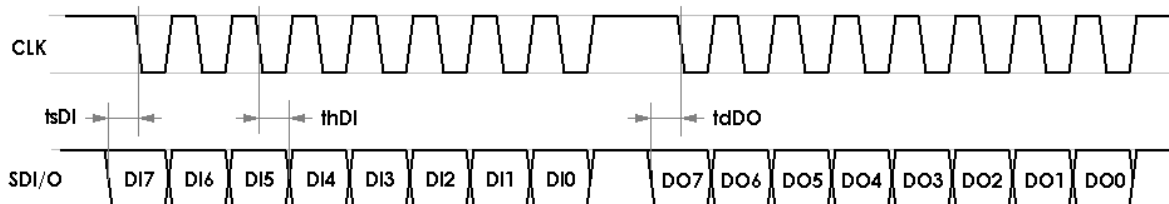

t_{sDI} set up time 10 ns min
 t_{dDO} delay time 10 ns min

t_{hDI} hold time 10 ns min
 t_{cyc} cycle time 250 ns min (4 MHz max)

→ The SPI command format: The first Byte defines the Command (see Command set). Depending on the Command, several bytes may follow. A 0x43-Byte ends the Command and Q5 starts process data.

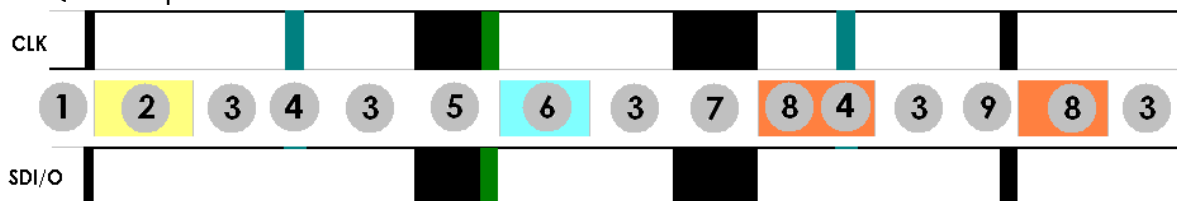

- | | |
|--|--|
| 1: Power on Reset (POR) | 6: Q5 is busy. Busy time depends on |
| 2: Initialisation Q5 command (see command set) | 7: Faulty command without 0x43 at end |
| 3: Idle, no SPI communication | 8: Timeout of 1,03ms, then Initialisation |
| 4: 0xff (NOP) on SPI, no effect | 9: Single Byte (not 0x43 or 0xff) to force Timeout |
| 5: Command, last Byte is 0x43 | |

☐ After Power on Reset (1-2-3) Q5 waits for commands (3-5-6-3). If a command fails, Q5 waits for the end of command (EOC) Byte 0x43 (3-7-8-3). In every situation the no operation Command (NOP) 0xff (4) is allowed. To force an initialisation of the SPI, send a single byte (not EOC or NOP) with a delay > 1.03 ms (3-9-8-3). Timeout triggers after every incoming byte (exceptions are NOP and OEC). In consequence the bytes of a command should arrive faster than every ms.

Command list

Command type	CMD	Data	Description
WriteDisplay Data	0x40	The command expects min. 4 bytes to follow: 0000 000A ₈ 0000 A ₇ A ₆ A ₅ A ₄ 0000 A ₃ A ₂ A ₁ A ₀ 0000 D ₃ D ₂ D ₁ D ₀ Max 511 more Data Bytes may follow Last byte is EOC 0x43	A8-A0 points into display, see diagram for address position D3 – D0 defines Dot pattern End of command
Set RGB Colour	0x41	The command expects 1 data Byte to follow: 00D ₅ D ₄ D ₃ D ₂ D ₁ D ₀ last byte is EOC 0x43	D ₅ , D ₄ , D ₃ , D ₂ , D ₁ , D ₀ define brightness of red, green and blue End of command
Set RGB Colour	0x42	The command expects 3 data Bytes to follow: 0D ₆ D ₅ D ₄ D ₃ D ₂ D ₁ D ₀ 0D ₆ D ₅ D ₄ D ₃ D ₂ D ₁ D ₀ 0D ₆ D ₅ D ₄ D ₃ D ₂ D ₁ D ₀ Last byte is EOC 0x43	D ₆ -D ₀ , D ₆ -D ₀ and D ₆ -D ₀ define brightness of red, green and blue backlight End of command
End of Command	0x43	0100 0011	Last byte for each command
WriteDisplay Data	0x48	The command expects min. 4 bytes to follow: 0000 000A ₈ 0000 A ₇ A ₆ A ₅ A ₄ 0000 A ₃ A ₂ A ₁ A ₀ 0000 D ₃ D ₂ D ₁ D ₀ Max 511 more Data Bytes may follow Last byte is EOC 0x43	A8-A0 points into display, see diagram for address position D3 – D0 defines Dot pattern End of command
WriteDisplay Data	0x49	The command expects 512 bytes to follow: 0000 D ₃ D ₂ D ₁ D ₀ Last byte is EOC 0x43	See diagram for dot position D3 – D0 defines Dot pattern End of command

CMD 0x40 write display

This command writes to the display. First address (Adr 0) is in the middle of the display on the right side. The following 3 bytes define the start address where the first 4 dots should be set. Then 1 to 512 bytes follow to define 4 dots each. This command should be used to archive compatibility. It is recommended to use command 0x48 for new projects. This dot map defines the position of the following data byte.

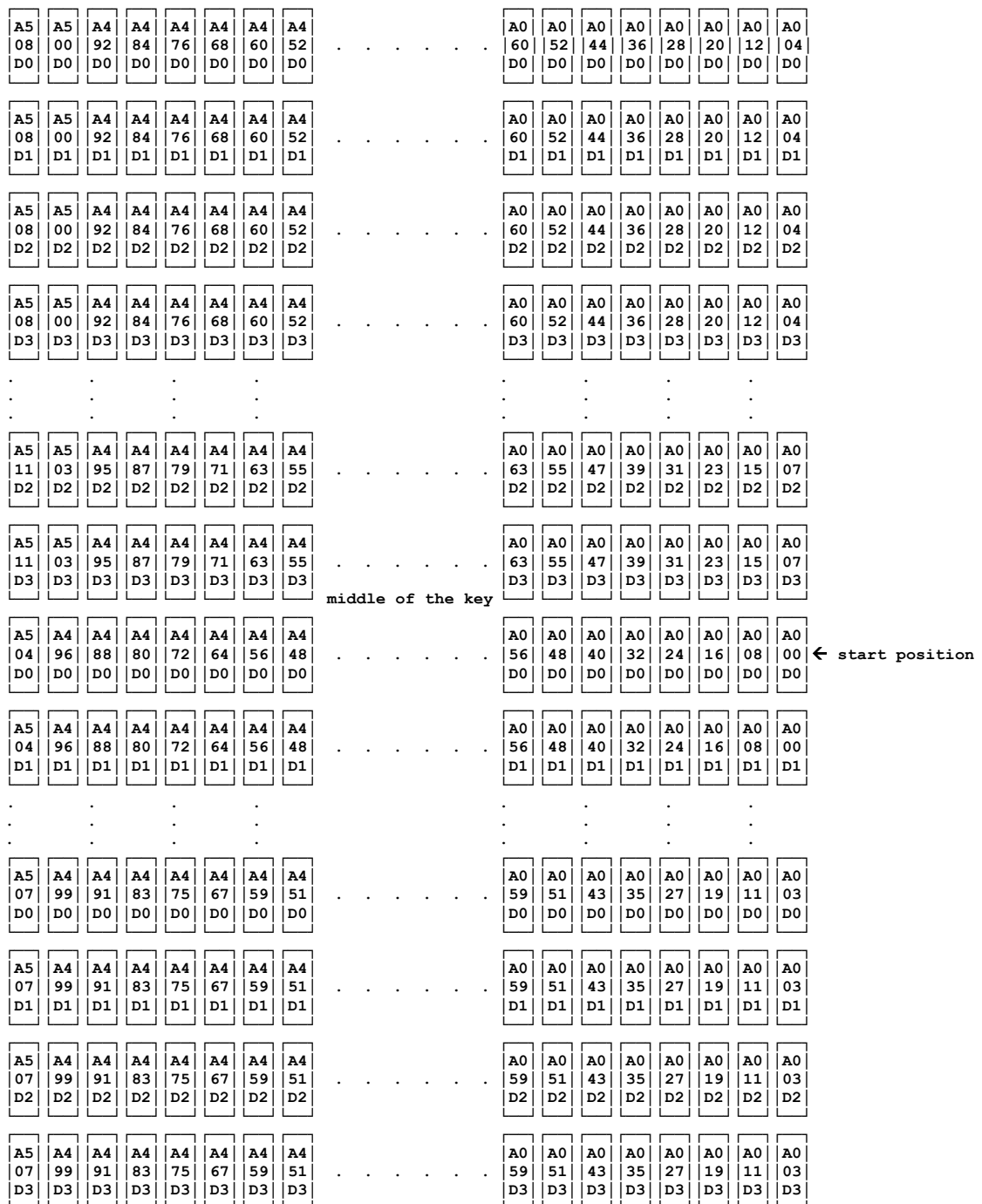

CMD 0x48 write display

This command writes to the display. First address (Adr 0) is in the upper right corner of the display. The following 3 bytes define the start address where the first 4 dots should be set. Then 1 to 512 bytes follow to define 4 dots each. It is recommended to use command 0x48 for new projects. This dot map defines the position of the following data byte.

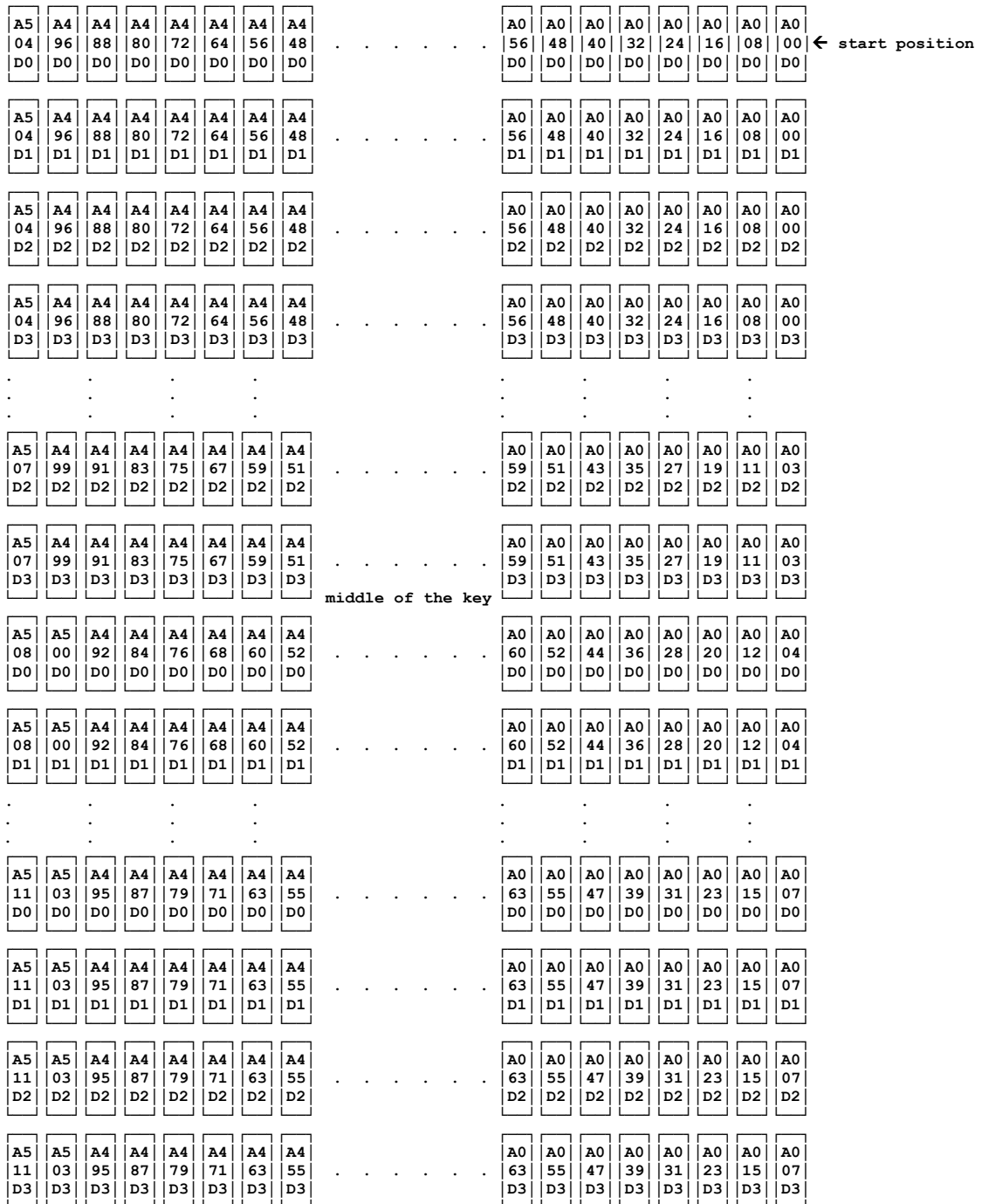

CMD 0x49 write display

This command writes to the display. First address (Adr 0) is in the upper left corner of the display. The start position for the dots is fixed and the command needs 512 bytes with dot information. The display is filled line by line. Command 0x49 is recommended to write text into the display. The data byte can be taken from a font character. This dot map shows the position of the dots in the data stream.

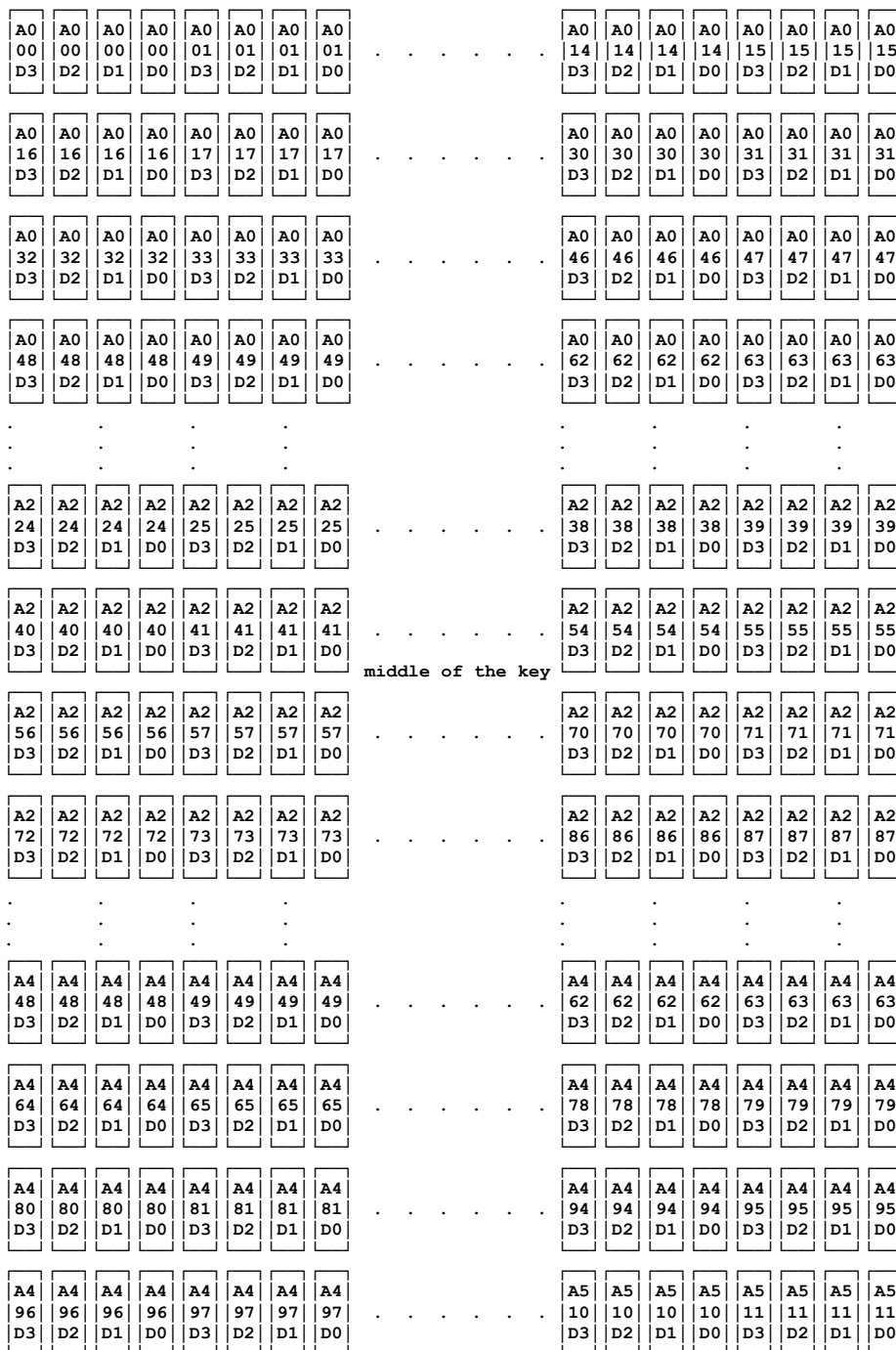

Command set overview

Command name	Cmd byte	Data amount	Busy time	Remarks
Write display half offset	0x40	Adr, 1 - 512 bytes	4 ms	
64 colours backlight	0x41	1 fix	100 us	
RGB colours backlight	0x42	3 fix	150 us	
End Of Command	0x43	0	/	EOC
Write display vertical	0x48	Adr, 1 - 512 bytes	4 ms	
Write display horizontal	0x49	512 bytes fix	5 ms	
No operation	0xFF	0	/	Other key active

Write command 0x40:

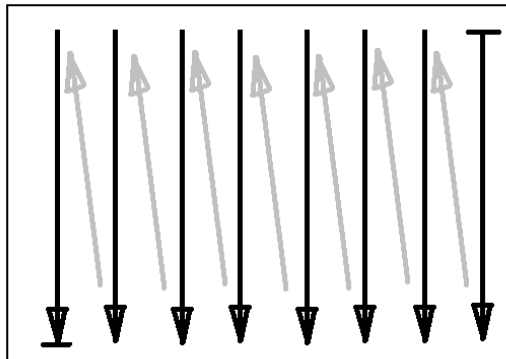
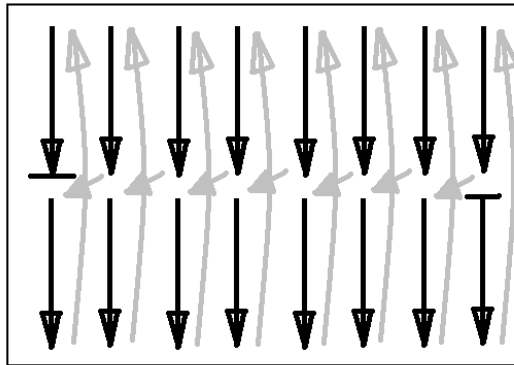

Write command 0x48:
command 0x49:

Write

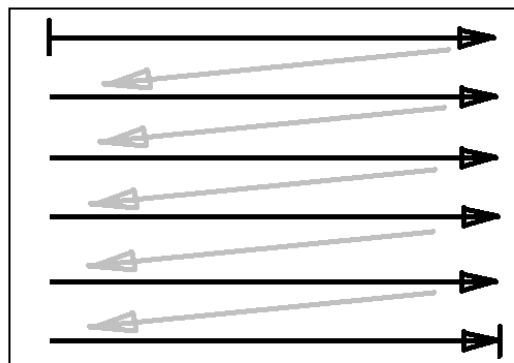

Outline Dimensions

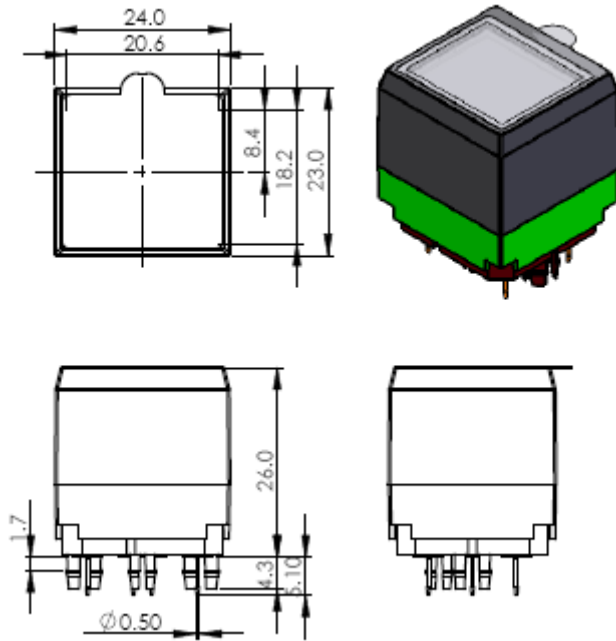

Footprint

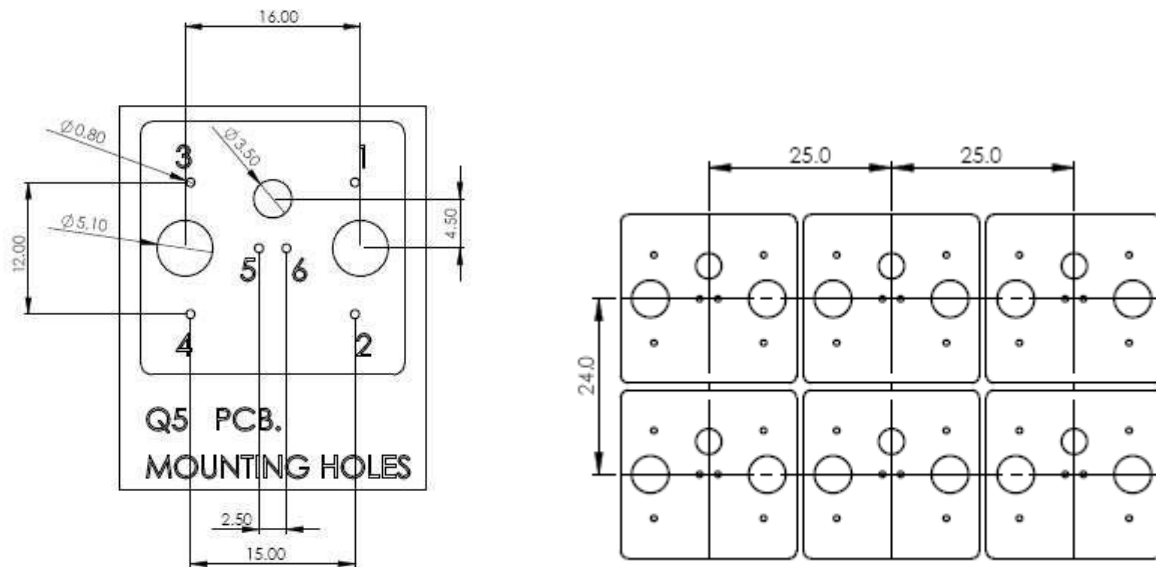

1: GND 2: Vcc 3: Clock 4: Data 5,6 : Switch

Packaging

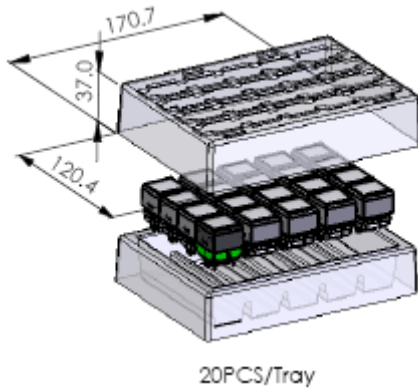

Address

MMI Technologies Ltd
West One
63 – 67 Bromham Road
Bedford
United Kingdom MK40 2FG
Tel: +44 (0) 1234 213 600
Fax: +44 (0) 1234 210 820
Email: info@mmi-technologies.com
www.mmi-technologies.com



History

Revision	Date	Comment
0.1	09-09-2008	First draw
0.9	09-09-2011	Commands added
1.0	18-01-2014	Current consumption added